



DATA SHEET

SKY67111-396LF: 0.7-1.2 GHz High Linearity, Active Bias Low-Noise Amplifier

Applications

- CDMA, WCDMA, and LTE cellular infrastructure
- Ultra low-noise systems

Features

- Ultra Low Noise Figure: 0.51 dB @ 0.9 GHz
- Input return loss > 18 dB @ 0.9 GHz
- High IIP3 performance: +18.9 dBm @ 0.9 GHz
- Adjustable supply current and gain
- Temperature and process-stable active bias
- Miniature DFN (8-pin, 2 x 2 mm) package (MSL1 @ 260 °C per JEDEC J-STD-020)

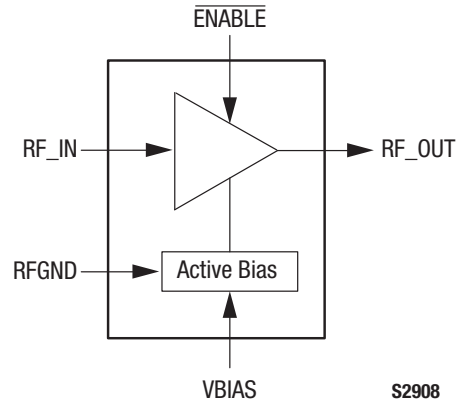

Figure 1. SKY67111-396LF Block Diagram



Skyworks Green™ products are compliant with all applicable legislation and are halogen-free. For additional information, refer to *Skyworks Definition of Green™*, document number SQ04-0074.

Description

The SKY67111-396LF is GaAs, pHEMT Low-Noise Amplifier (LNA) with an active bias and high linearity performance. The advanced GaAs pHEMT enhancement mode process provides excellent return loss, low noise, and high linearity performance.

The internal active bias circuitry provides stable performance over temperature and process variation. The device offers the ability to externally adjust supply current and gain. Supply voltage is applied to the RFOUT/VDD pin through an RF choke inductor. Pin 4 (VBIAS) should be connected to RFOUT/VDD through an external resistor to control the supply current. The RFIN and RFOUT/VDD pins should be DC blocked to ensure proper operation. Pin 5 (FEEDBACK) is connected through an RC network to externally adjust the gain of the device without affecting the Noise Figure (NF) of the LNA.

The SKY67111-396LF operates in the frequency range of 0.7 to 1.2 GHz with proper tuning.

The LNA is manufactured in a compact, 2 x 2 mm, 8-pin Dual Flat No-Lead (DFN) package. A functional block diagram is shown in Figure 1. The pin configuration and package are shown in Figure 2. Signal pin assignments and functional pin descriptions are provided in Table 1.

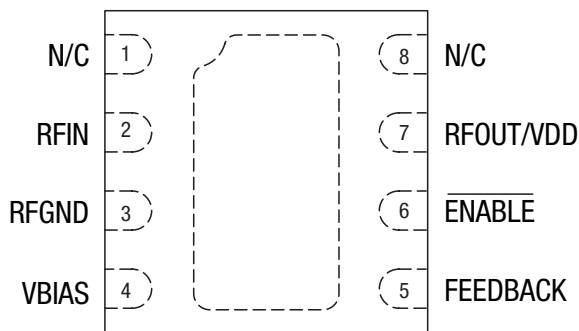

S2786

Figure 2. SKY67111-396LF Pinout – 8-Pin DFN (Top View)

Table 1. SKY67111-396LF Signal Descriptions

Pin #	Name	Description	Pin #	Name	Description
1	N/C	No connection. May be connected to ground with no change in performance.	5	FEEDBACK	LNA external gain control. Connect to RFOUT using a series RC network.
2	RFIN	RF input. DC blocking capacitor required.	6	$\overline{\text{ENABLE}}$	Enable pin. Active low (0 V) = amplifier “on” state.
3	RFGND	RF ground. Connect to ground through a capacitor.	7	RFOUT/VDD	RF output. Apply VDD through RF choke inductor. DC blocking capacitor required.
4	VBIAS	LNA supply current. Connect through series resistor to VDD or bias separately through DC header, pin 4.	8	N/C	No connection. May be connected to ground with no change in performance.

Table 2. SKY67111-396LF Absolute Maximum Ratings

Parameter	Symbol	Minimum	Typical	Maximum	Units
Supply voltage	V _{DD}			5.5	V
RF input power	P _{IN}			+20	dBm
Storage temperature	T _{STG}	-65	+25	+125	°C
Thermal resistance	J _C		62.2		°C/W
Operating temperature	T _A	-40	+25	+100	°C
Junction temperature	T _J			+150	°C

Note: Exposure to maximum rating conditions for extended periods may reduce device reliability. There is no damage to device with only one parameter set at the limit and all other parameters set at or below their nominal value. Exceeding any of the limits listed here may result in permanent damage to the device.

CAUTION: Although this device is designed to be as robust as possible, Electrostatic Discharge (ESD) can damage this device. This device must be protected at all times from ESD. Static charges may easily produce potentials of several kilovolts on the human body or equipment, which can discharge without detection. Industry-standard ESD precautions should be used at all times. The SKY67111-396LF ESD threshold level is 500 V using Human Body Model (HBM) Class B testing; 30 V using Man-Machine (MM) Class A testing; and 1000 V using Charged Device Model (CDM) Class IV testing.

Electrical and Mechanical Specifications

The absolute maximum ratings of the SKY67111-396LF are provided in Table 2. Electrical specifications are provided in Table 3.

Typical performance characteristics of the SKY67111-396LF are illustrated in Figures 3 through 23.

Table 4 provides noise source pull information versus frequency.

Table 3. SKY67111-396LF Electrical Specifications (Note 1)**(V_{DD} = 5.0 V, I_{DD} = 77 mA, T_A = +25 °C, P_{IN} = -20 dBm, Characteristic Impedance [Z₀] = 50 Ω, Unless Otherwise Noted)**

Parameter	Symbol	Test Condition	Min	Typical	Max	Units
RF Specifications						
Noise Figure (Note 2)	NF	@ 0.9 GHz		0.51	0.85	dB
Small signal gain	S ₂₁	@ 0.9 GHz	18.7	20.7		dB
Input return loss	S ₁₁	@ 0.9 GHz	15	18		dB
Output return loss	S ₂₂	@ 0.9 GHz	14	17		dB
Reverse isolation	S ₁₂	@ 0.9 GHz	27	30		dB
3 rd Order Input Intercept Point	IIP3	@ 0.9 GHz, f = 10 MHz, P _{IN} = -20 dBm/tone	+16.4	+18.9		dBm
3 rd Order Output Intercept Point	OIP3	@ 0.9 GHz, f = 10 MHz, P _{IN} = -20 dBm/tone	+37.1	+39.6		dBm
1 dB Input Compression Point	IP1dB	@ 0.9 GHz	-1.7	+0.3		dBm
1 dB Output Compression Point	OP1dB	@ 0.9 GHz	+18	+20		dBm
DC Specifications						
Supply voltage	V _{DD}			5		V
Supply current	I _{DD}	Set with external resistor		77		mA
Amplifier enable off current (logic "high")	I _{EN}			700	1000	A
Enable time	t _R	@ 0.9 GHz, 90% RF			100	s
Disable time	t _F	@ 0.9 GHz, 10% RF			100	s

Note 1: Performance is guaranteed only under the conditions listed in this Table.**Note 2:** Board and connector losses have not been de-embedded.

Typical Performance Characteristics

(VDD = 5.0 V, IDD = 77 mA, TA = +25 °C, PIN = -20 dBm, Characteristic Impedance [Zo] = 50 Ω, Unless Otherwise Noted)

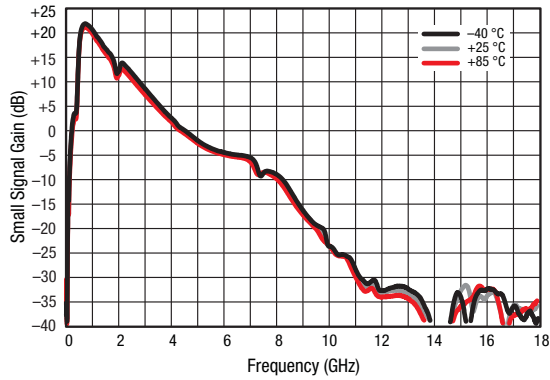

Figure 3. Broadband Gain Response vs Frequency Over Temperature

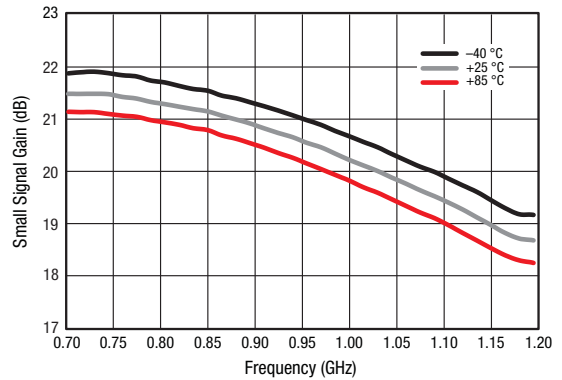

Figure 4. Narrowband Gain Response vs Frequency Over Temperature

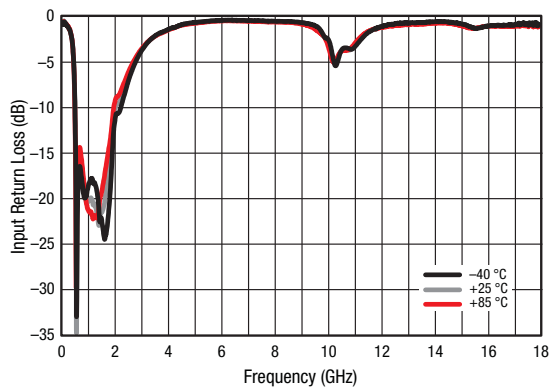

Figure 5. Broadband Input Return Loss vs Frequency Over Temperature

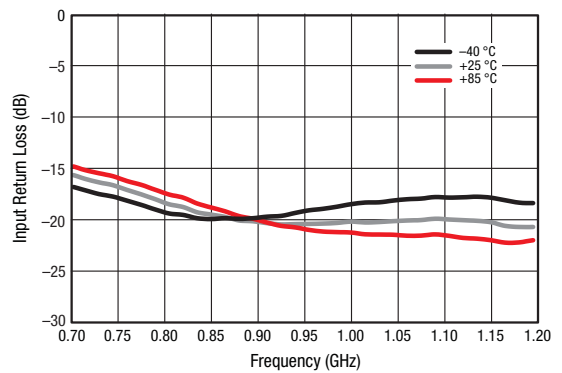

Figure 6. Narrowband Input Return Loss vs Frequency Over Temperature

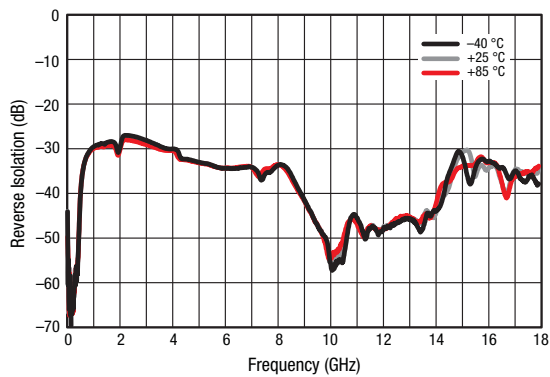

Figure 7. Broadband Reverse Isolation vs Frequency Over Temperature

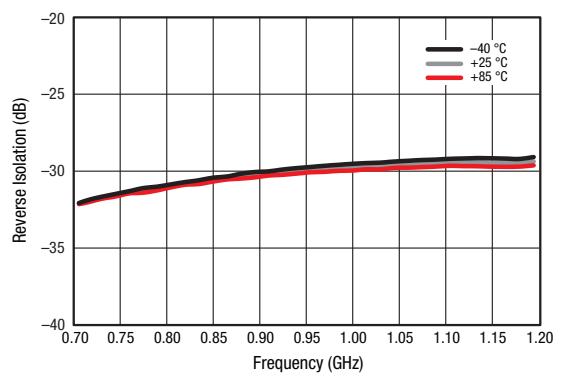

Figure 8. Narrowband Reverse Isolation vs Frequency Over Temperature

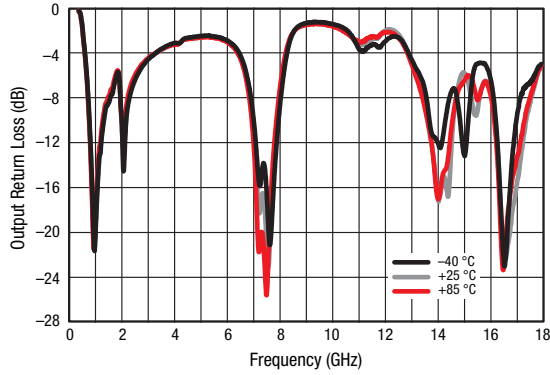

Figure 9. Broadband Output Return Loss vs Frequency Over Temperature

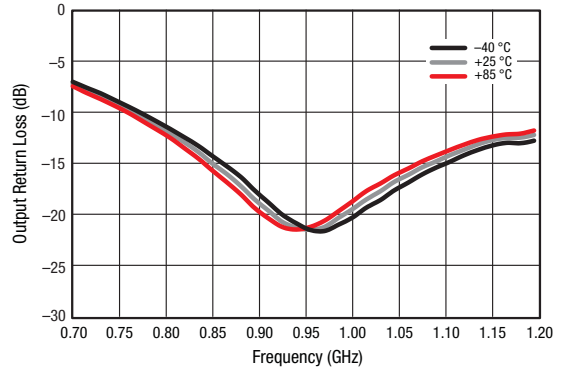

Figure 10. Narrowband Output Return Loss vs Frequency Over Temperature

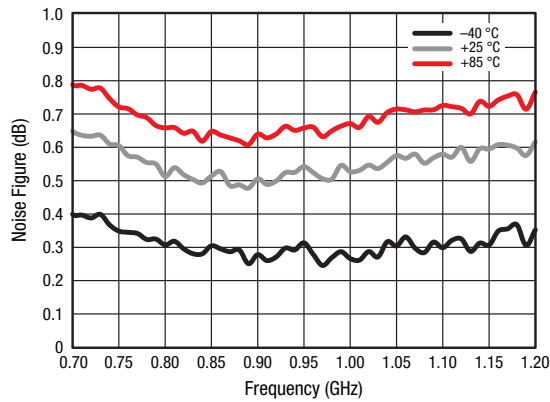

Figure 11. Noise Figure vs Frequency Over Temperature

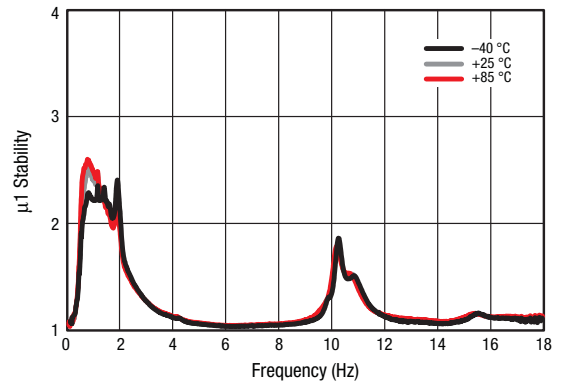

Figure 12. 1 Stability vs Frequency Over Temperature

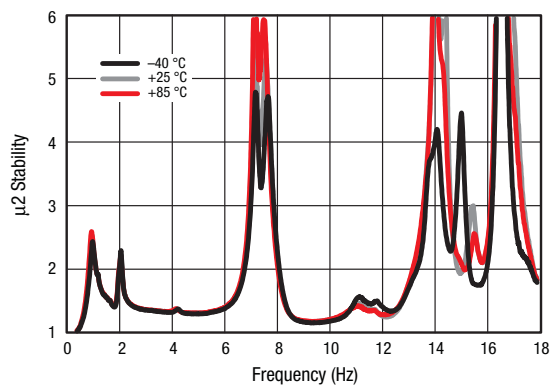

Figure 13. 2 Stability vs Frequency Over Temperature

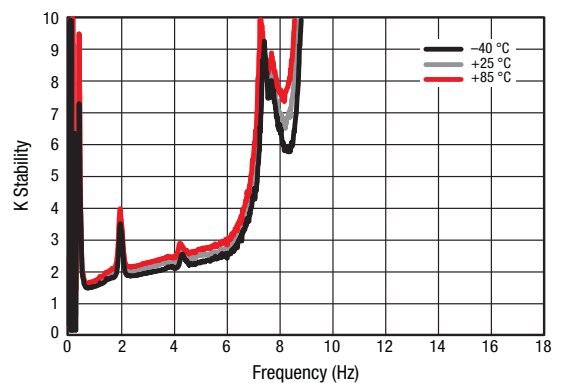

Figure 14. K Stability vs Frequency Over Temperature

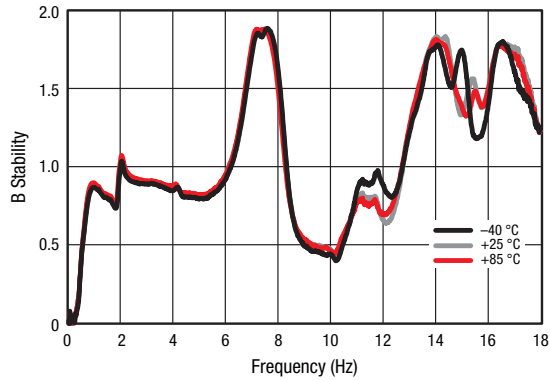

Figure 15. B Stability vs Frequency Over Temperature

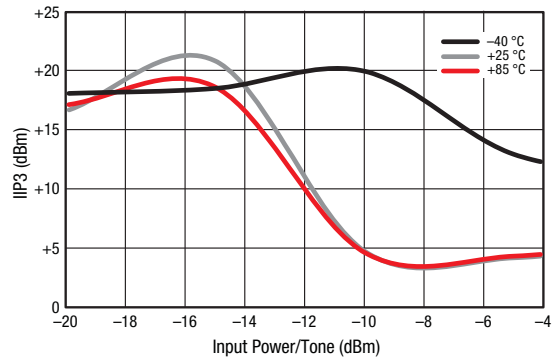

Figure 16. IIP3 vs Temperature (@ 700 MHz)

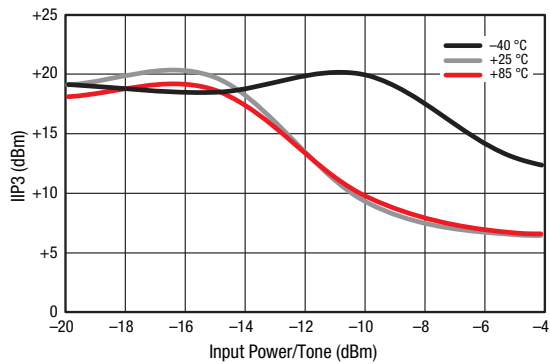

Figure 17. IIP3 vs Temperature (@ 900 MHz)

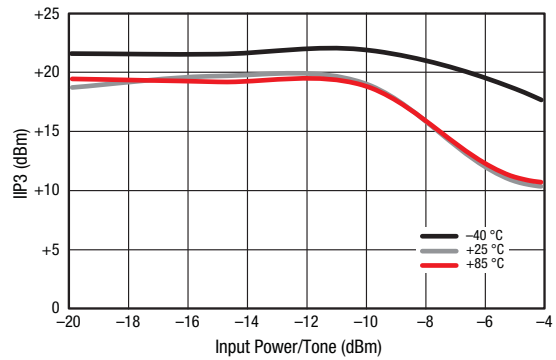

Figure 18. IIP3 vs Temperature (@ 1200 MHz)

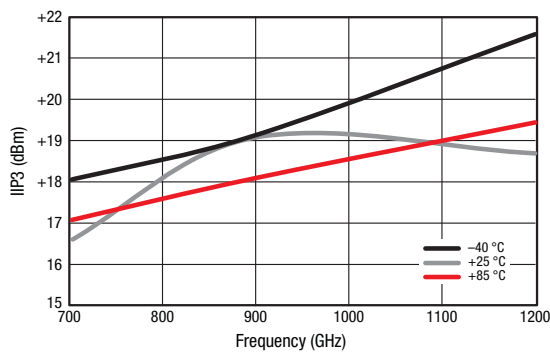

Figure 19. IIP3 vs Frequency Over Temperature

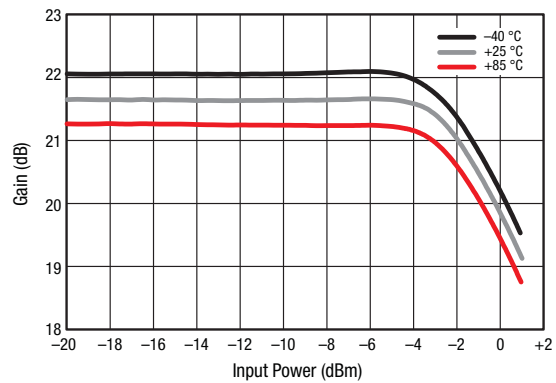

Figure 20. IP1dB vs Temperature (@ 700 MHz)

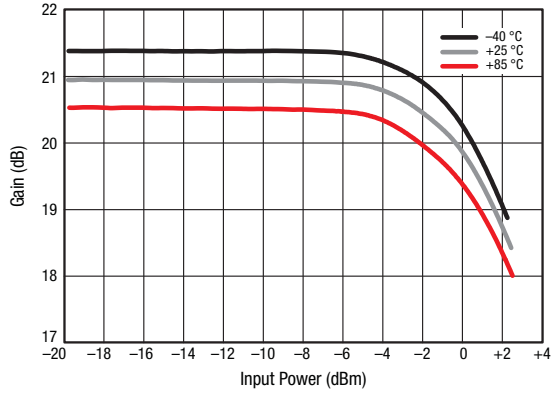

Figure 21. IP1dB vs Temperature (@ 900 MHz)

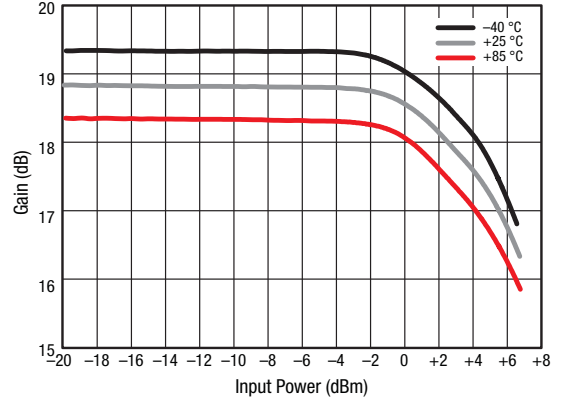

Figure 22. IP1dB vs Temperature (@ 1200 MHz)

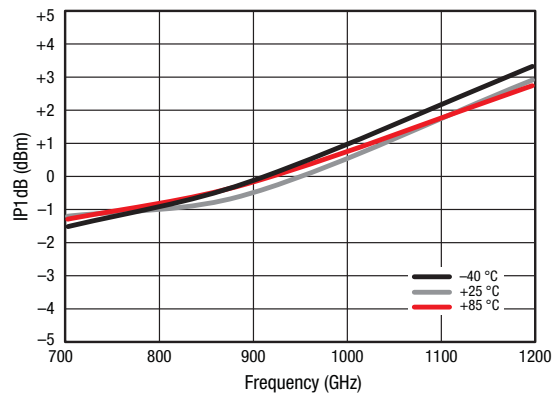

Figure 23. IP1dB vs Frequency Over Temperature

Table 4. Noise Parameters vs Frequency (1 of 3)

Frequency (GHz)	Minimum Noise Figure (F _{MIN}) (dB)	Noise Resistance (R _N) (Ω)	Γ _{opt}		Associated Gain (dB)	Maximum Gain (G _{MAX}) (dB)
			Magnitude	Phase		
5 V, 77 mA						
0.35	0.4700	0.0363	0.2633	38.28	27.0981	27.71639574
0.40	0.4671	0.0375	0.2545	44.45	26.3968	26.90686823
0.45	0.4613	0.0390	0.2470	49.89	25.7329	26.1476215
0.50	0.4534	0.0407	0.2409	54.76	25.1049	25.43634075
0.55	0.4442	0.0424	0.2358	59.22	24.5110	24.77071117
0.60	0.4342	0.0441	0.2318	63.40	23.9499	24.14841795
0.65	0.4240	0.0458	0.2286	67.43	23.4198	23.56714629
0.70	0.4142	0.0473	0.2262	71.42	22.9192	23.02458137
0.75	0.4052	0.0486	0.2245	75.45	22.4466	22.51840838
0.80	0.3975	0.0497	0.2234	79.59	22.0002	22.04631252
0.85	0.3913	0.0505	0.2228	83.91	21.5787	21.60597898
0.90	0.3870	0.0511	0.2227	88.45	21.1803	21.19509295
0.95	0.3848	0.0514	0.2230	93.23	20.8035	20.81133963
1.00	0.3849	0.0513	0.2236	98.27	20.4467	20.45240419
1.05	0.3874	0.0510	0.2246	103.56	20.1084	20.11597184
1.10	0.3924	0.0504	0.2260	109.07	19.7869	19.79972777
1.15	0.3998	0.0496	0.2276	114.77	19.4807	19.50135716
1.20	0.4097	0.0486	0.2297	120.61	19.1882	19.21854522
1.25	0.4219	0.0474	0.2320	126.52	18.9078	18.94897712
1.30	0.4363	0.0461	0.2348	132.40	18.6379	18.69033807
1.35	0.4526	0.0448	0.2381	138.17	18.3770	18.44031325
1.40	0.4706	0.0436	0.2418	143.70	18.1235	18.19658785
1.45	0.4900	0.0424	0.2461	148.87	17.8757	17.95684708
1.50	0.5103	0.0416	0.2511	153.51	17.6321	17.71877611
1.55	0.5311	0.0410	0.2568	157.47	17.3912	17.48006014
1.60	0.5519	0.0410	0.2634	160.57	17.1513	17.23838436
1.65	0.5721	0.0415	0.2709	162.61	16.9109	16.99143397
1.70	0.5912	0.0428	0.2796	163.37	16.6684	16.73689415
1.75	0.6084	0.0449	0.2895	162.64	16.4221	16.47245009
1.80	0.6230	0.0481	0.3007	160.15	16.1706	16.19578699

Table 4. Noise Parameters vs Frequency (2 of 3)

Frequency (GHz)	Minimum Noise Figure (F _{MIN}) (dB)	Noise Resistance (R _N) (Ω)	Γ _{opt}		Associated Gain (dB)	Maximum Gain (G _{MAX}) (dB)
			Magnitude	Phase		
5.0 V, 30 mA						
0.35	0.4402	0.0730	0.3118	38.05	25.7382	26.97103057
0.40	0.4443	0.0652	0.3000	42.52	25.0574	26.09690056
0.45	0.4450	0.0592	0.2915	46.74	24.4137	25.28217427
0.50	0.4431	0.0548	0.2858	50.81	23.8055	24.52397611
0.55	0.4393	0.0518	0.2824	54.79	23.2313	23.81943052
0.60	0.4344	0.0498	0.2809	58.74	22.6895	23.16566193
0.65	0.4290	0.0487	0.2810	62.73	22.1786	22.55979477
0.70	0.4237	0.0483	0.2823	66.79	21.6969	21.99895347
0.75	0.4191	0.0483	0.2845	70.97	21.2430	21.48026245
0.80	0.4155	0.0487	0.2873	75.29	20.8151	21.00084614
0.85	0.4134	0.0492	0.2905	79.77	20.4118	20.55782899
0.90	0.4131	0.0498	0.2940	84.43	20.0316	20.1483354
0.95	0.4149	0.0504	0.2974	89.25	19.6727	19.76948982
1.00	0.4191	0.0508	0.3007	94.24	19.3337	19.41841667
1.05	0.4258	0.0510	0.3038	99.38	19.0130	19.09224039
1.10	0.4350	0.0510	0.3066	104.64	18.7089	18.7880854
1.15	0.4469	0.0507	0.3090	109.98	18.4201	18.50307613
1.20	0.4614	0.0501	0.3110	115.36	18.1448	18.23433701
1.25	0.4784	0.0493	0.3127	120.72	17.8815	17.97899247
1.30	0.4977	0.0482	0.3141	126.00	17.6286	17.73416694
1.35	0.5193	0.0469	0.3153	131.14	17.3847	17.49698486
1.40	0.5428	0.0456	0.3164	136.04	17.1480	17.26457064
1.45	0.5678	0.0442	0.3176	140.62	16.9170	17.03404871
1.50	0.5941	0.0429	0.3190	144.78	16.6902	16.80254352
1.55	0.6211	0.0418	0.3209	148.41	16.4660	16.56717948
1.60	0.6483	0.0410	0.3236	151.40	16.2428	16.32508103
1.65	0.6752	0.0408	0.3272	153.60	16.0191	16.0733726
1.70	0.7012	0.0413	0.3321	154.90	15.7933	15.80917861
1.75	0.7255	0.0428	0.3388	155.14	15.5637	15.5296235
1.80	0.7474	0.0454	0.3474	154.18	15.3289	15.23183169

Table 4. Noise Parameters vs Frequency (3 of 3)

Frequency (GHz)	Minimum Noise Figure (F _{MIN}) (dB)	Noise Resistance (R _N) (Ω)	Γ _{opt}		Associated Gain (dB)	Maximum Gain (G _{MAX}) (dB)
			Magnitude	Phase		
5.0 V, 100 mA						
0.35	0.4684	0.0339	0.2244	37.56	27.3643	27.94143158
0.40	0.4617	0.0360	0.2184	44.28	26.6614	27.14073024
0.45	0.4539	0.0382	0.2121	50.08	25.9960	26.38848843
0.50	0.4455	0.0404	0.2057	55.14	25.3665	25.68252253
0.55	0.4370	0.0426	0.1995	59.65	24.7713	25.02064891
0.60	0.4288	0.0446	0.1937	63.75	24.2088	24.40068394
0.65	0.4214	0.0465	0.1885	67.58	23.6773	23.820444
0.70	0.4151	0.0482	0.1841	71.28	23.1753	23.27774545
0.75	0.4102	0.0496	0.1806	74.95	22.7011	22.77040467
0.80	0.4070	0.0508	0.1781	78.68	22.2531	22.29623803
0.85	0.4058	0.0517	0.1768	82.55	21.8296	21.8530619
0.90	0.4067	0.0523	0.1767	86.61	21.4292	21.43869265
0.95	0.4098	0.0525	0.1778	90.92	21.0502	21.05094665
1.00	0.4153	0.0525	0.1801	95.50	20.6909	20.68764027
1.05	0.4230	0.0522	0.1837	100.37	20.3497	20.3465899
1.10	0.4331	0.0516	0.1886	105.51	20.0250	20.02561188
1.15	0.4455	0.0508	0.1945	110.90	19.7153	19.72252261
1.20	0.4600	0.0497	0.2016	116.52	19.4189	19.43513845
1.25	0.4765	0.0485	0.2096	122.30	19.1341	19.16127577
1.30	0.4947	0.0471	0.2184	128.18	18.8594	18.89875094
1.35	0.5145	0.0456	0.2279	134.07	18.5931	18.64538034
1.40	0.5355	0.0441	0.2379	139.87	18.3337	18.39898033
1.45	0.5574	0.0426	0.2481	145.47	18.0795	18.15736729
1.50	0.5797	0.0413	0.2583	150.72	17.8289	17.91835759
1.55	0.6021	0.0401	0.2683	155.47	17.5803	17.6797676
1.60	0.6240	0.0393	0.2777	159.57	17.3321	17.43941369
1.65	0.6448	0.0388	0.2863	162.83	17.0826	17.19511224
1.70	0.6641	0.0388	0.2937	165.05	16.8303	16.94467961
1.75	0.6811	0.0394	0.2996	166.01	16.5735	16.68593218
1.80	0.6952	0.0408	0.3035	165.49	16.3107	16.41668632

Evaluation Board Description

The SKY67111-396LF Evaluation Board is used to test the performance of the SKY67111-396LF LNA. An assembly drawing for the Evaluation Board is shown in Figure 24. An Evaluation Board schematic diagram is provided in Figure 25. Table 5 provides the Bill of Materials (BOM) list for Evaluation Board components.

The test board uses a 10 mil Rogers 4350B substrate on a 50 mil FR4 supporting substrate. The Rogers 4350B material was selected for the RF circuit because of its low dielectric constant (ϵ_r) and low ϵ_r variation over temperature for the best possible noise performance.

Package Dimensions

The PCB layout footprint for the SKY67111-396LF is provided in Figure 26. Typical case markings are shown in Figure 27. Package dimensions for the 8-pin DFN are shown in Figure 28, and tape and reel dimensions are provided in Figure 29.

Package and Handling Information

Instructions on the shipping container label regarding exposure to moisture after the container seal is broken must be followed. Otherwise, problems related to moisture absorption may occur when the part is subjected to high temperature during solder assembly.

THE SKY67111-396LF is rated to Moisture Sensitivity Level 1 (MSL1) at 260 °C. It can be used for lead or lead-free soldering. For additional information, refer to the Skyworks Application Note, *Solder Reflow Information*, document number 200164.

Care must be taken when attaching this product, whether it is done manually or in a production solder reflow environment. Production quantities of this product are shipped in a standard tape and reel format.

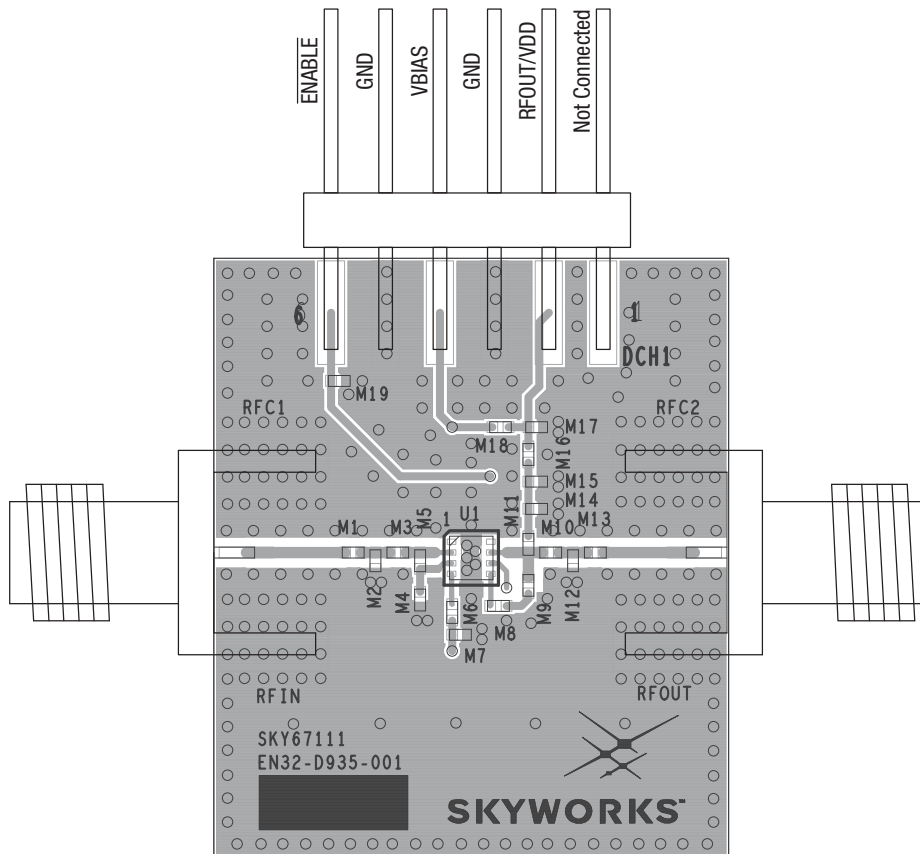

Figure 24. SKY67111-396LF Evaluation Board Assembly Diagram

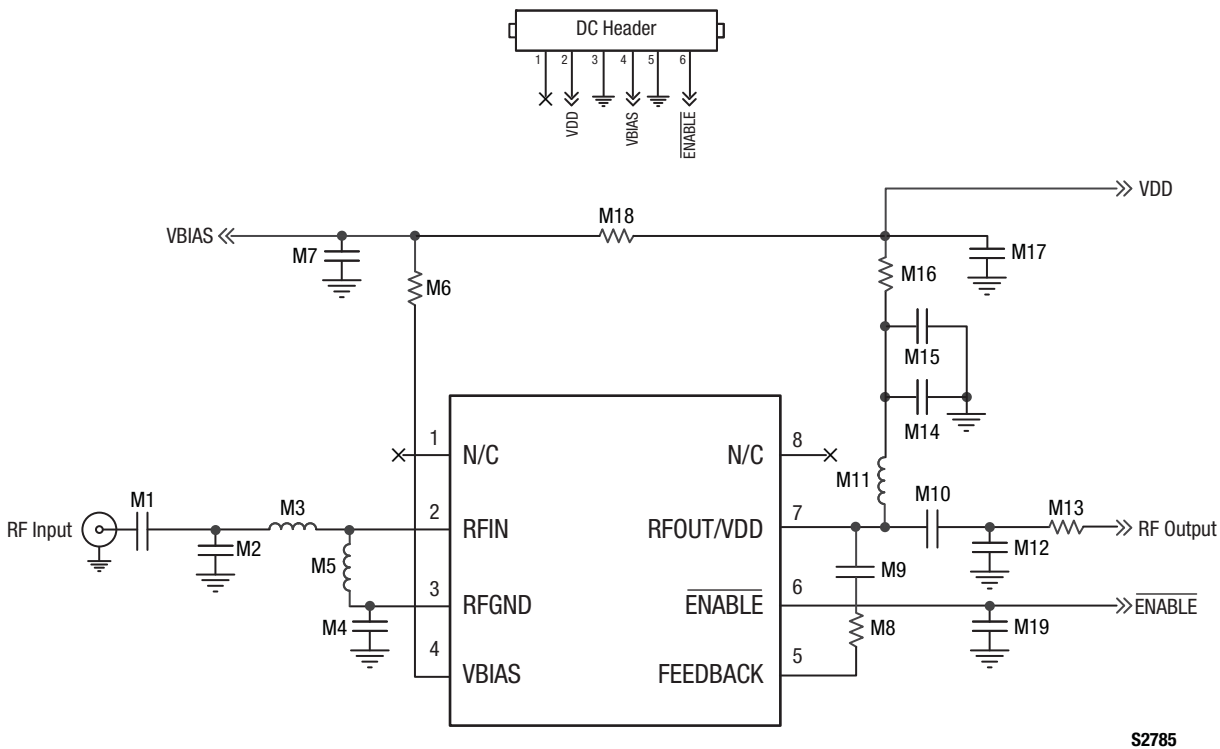
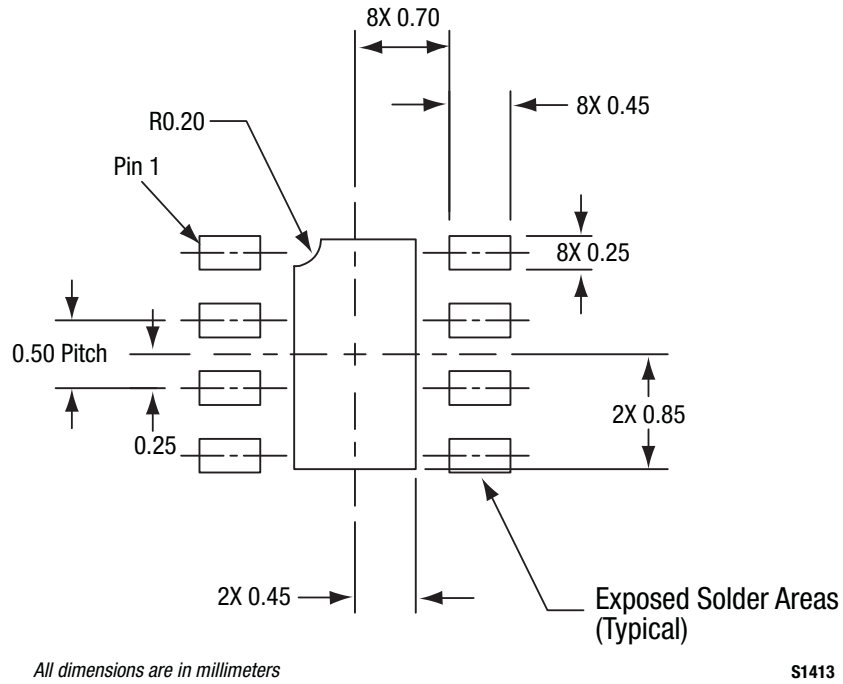

Figure 25. SKY67111-396LF Evaluation Board Schematic

Table 5. SKY67111-396LF Evaluation Board Bill of Materials

Component	Value	Size	Manufacturer
M1	10 pF	0402	Murata GJM
M2	DNI	–	–
M3	3.6 nH	0402	Coilcraft HP
M4	6.2 pF	0402	Murata GJM
M5	20 nH	0402	Coilcraft HP
M6	7500 Ω	0402	Panasonic
M7	1000 pF	0402	Murata GRM
M8	750 Ω	0402	Panasonic
M9	100 pF	0402	Murata GRM
M10	3.3 pF	0402	Murata GRM
M11	7.5 nH	0402	Murata LQG
M12	DNI	–	–
M13	0 Ω	0402	Panasonic
M14	3.9 pF	0402	Murata GRM
M15	DNI	–	–
M16	0 Ω	0402	Panasonic
M17	1000 pF	0402	Murata GRM
M18	0 Ω	0402	Panasonic
M19	1000 pF	0402	Murata GRM



S1413

Figure 26. SKY67111-396LF PCB Layout Footprint (Top View)

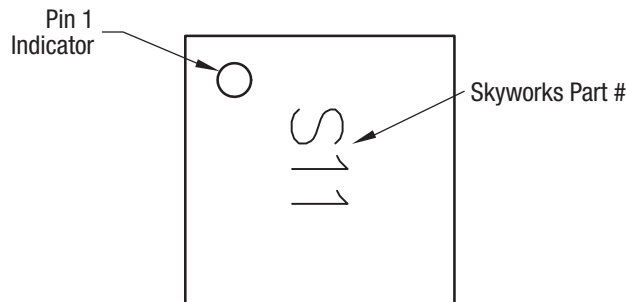
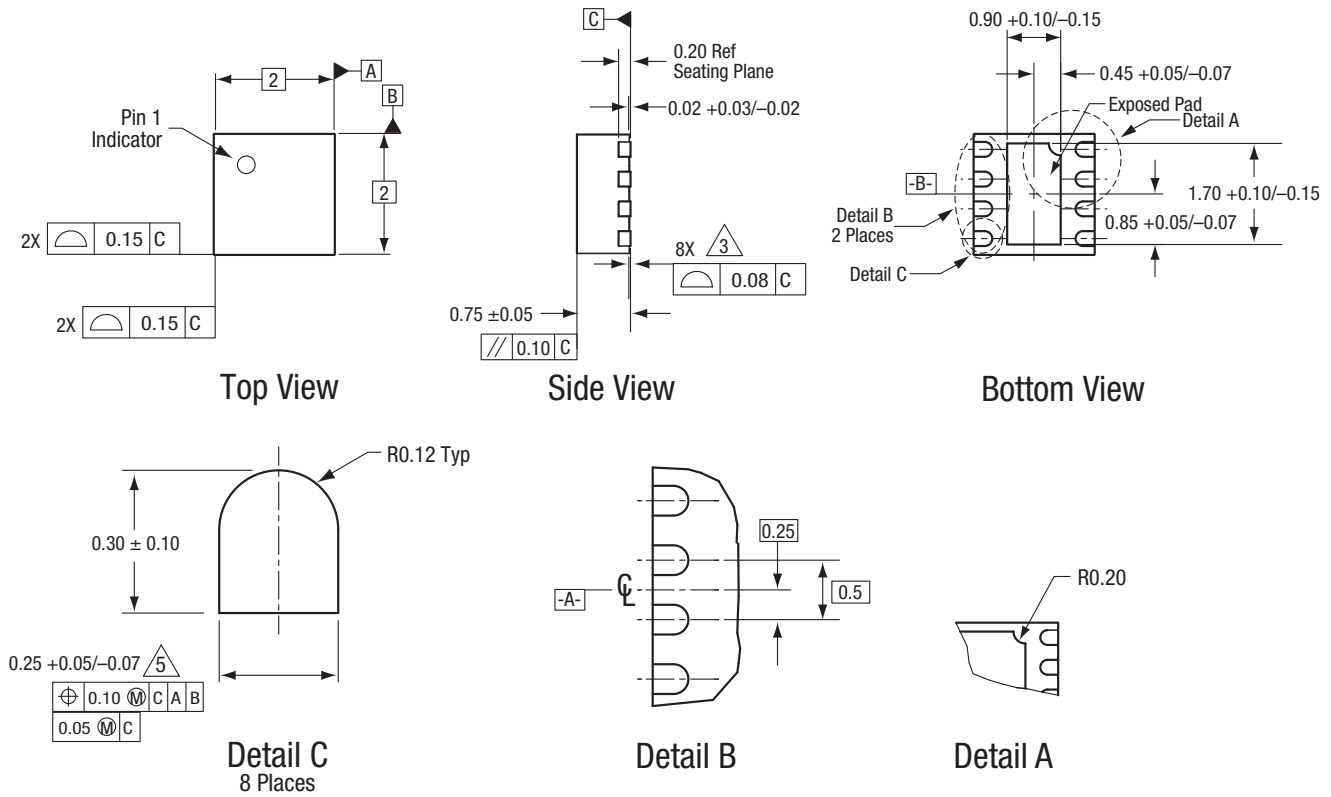

Figure 27. Typical Case Markings (Top View)



All measurements are in millimeters.
 Dimensioning and tolerancing according to ASME Y14.5M-1994.
 Coplanarity applies to the exposed heat sink slug as well as the terminals..
 Plating requirement per source control drawing (SCD) 2504.
 Dimension applies to metallized terminal and is measured between 0.15 mm and 0.30 mm from terminal tip.

S1945

Figure 28. SKY67111-396LF 8-Pin DFN Package Dimensions

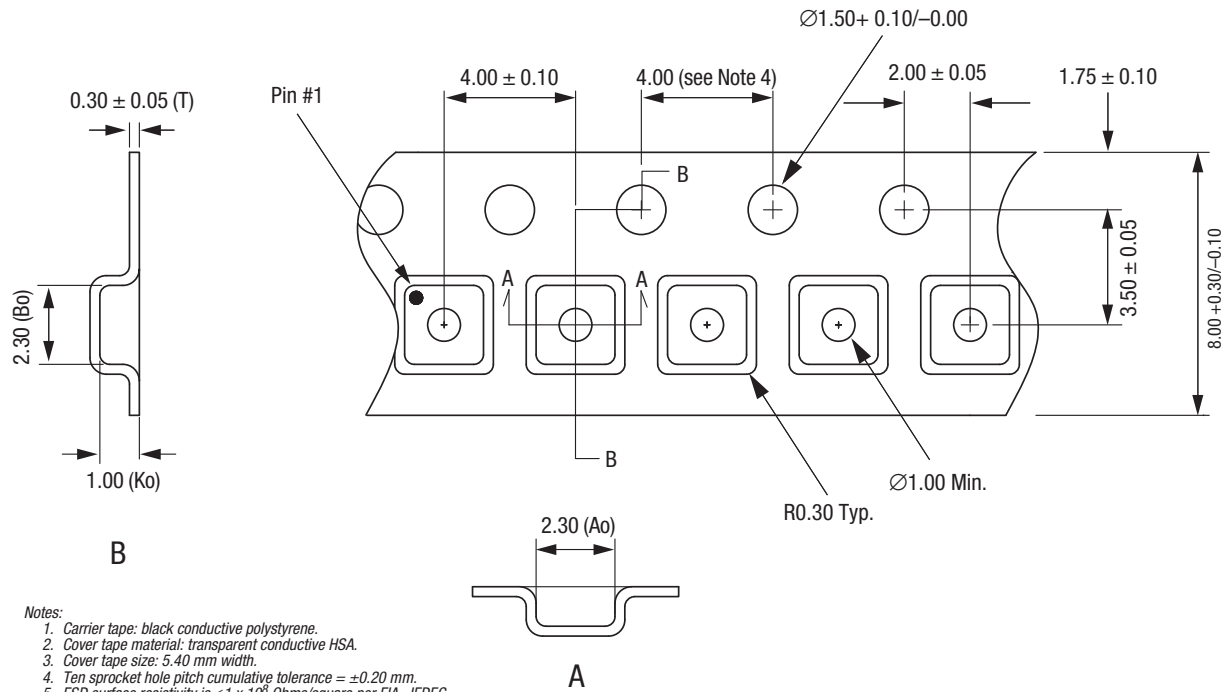

Notes:

1. Carrier tape: black conductive polystyrene.
2. Cover tape material: transparent conductive HSA.
3. Cover tape size: 5.40 mm width.
4. Ten sprocket hole pitch cumulative tolerance = ± 0.20 mm.
5. ESD surface resistivity is $\leq 1 \times 10^9$ Ohms/square per EIA, JEDEC tape and reel specification.
6. Ao and Bo measurement point to be 0.30 mm from bottom pocket.
7. All measurements are in millimeters.

S1601

Figure 29. SKY67111-396LF Tape and Reel Dimensions

Ordering Information

Model Name	Manufacturing Part Number	Evaluation Board Part Number
SKY67111-396LF LNA	SKY67111-396LF	SKY67111-396LF-EVB

Copyright © 2012 Skyworks Solutions, Inc. All Rights Reserved.

Information in this document is provided in connection with Skyworks Solutions, Inc. ("Skyworks") products or services. These materials, including the information contained herein, are provided by Skyworks as a service to its customers and may be used for informational purposes only by the customer. Skyworks assumes no responsibility for errors or omissions in these materials or the information contained herein. Skyworks may change its documentation, products, services, specifications or product descriptions at any time, without notice. Skyworks makes no commitment to update the materials or information and shall have no responsibility whatsoever for conflicts, incompatibilities, or other difficulties arising from any future changes.

No license, whether express, implied, by estoppel or otherwise, is granted to any intellectual property rights by this document. Skyworks assumes no liability for any materials, products or information provided hereunder, including the sale, distribution, reproduction or use of Skyworks products, information or materials, except as may be provided in Skyworks Terms and Conditions of Sale.

THE MATERIALS, PRODUCTS AND INFORMATION ARE PROVIDED "AS IS" WITHOUT WARRANTY OF ANY KIND, WHETHER EXPRESS, IMPLIED, STATUTORY, OR OTHERWISE, INCLUDING FITNESS FOR A PARTICULAR PURPOSE OR USE, MERCHANTABILITY, PERFORMANCE, QUALITY OR NON-INFRINGEMENT OF ANY INTELLECTUAL PROPERTY RIGHT; ALL SUCH WARRANTIES ARE HEREBY EXPRESSLY DISCLAIMED. SKYWORKS DOES NOT WARRANT THE ACCURACY OR COMPLETENESS OF THE INFORMATION, TEXT, GRAPHICS OR OTHER ITEMS CONTAINED WITHIN THESE MATERIALS. SKYWORKS SHALL NOT BE LIABLE FOR ANY DAMAGES, INCLUDING BUT NOT LIMITED TO ANY SPECIAL, INDIRECT, INCIDENTAL, STATUTORY, OR CONSEQUENTIAL DAMAGES, INCLUDING WITHOUT LIMITATION, LOST REVENUES OR LOST PROFITS THAT MAY RESULT FROM THE USE OF THE MATERIALS OR INFORMATION, WHETHER OR NOT THE RECIPIENT OF MATERIALS HAS BEEN ADVISED OF THE POSSIBILITY OF SUCH DAMAGE.

Skyworks products are not intended for use in medical, lifesaving or life-sustaining applications, or other equipment in which the failure of the Skyworks products could lead to personal injury, death, physical or environmental damage. Skyworks customers using or selling Skyworks products for use in such applications do so at their own risk and agree to fully indemnify Skyworks for any damages resulting from such improper use or sale.

Customers are responsible for their products and applications using Skyworks products, which may deviate from published specifications as a result of design defects, errors, or operation of products outside of published parameters or design specifications. Customers should include design and operating safeguards to minimize these and other risks. Skyworks assumes no liability for applications assistance, customer product design, or damage to any equipment resulting from the use of Skyworks products outside of stated published specifications or parameters.

Skyworks, the Skyworks symbol, and "Breakthrough Simplicity" are trademarks or registered trademarks of Skyworks Solutions, Inc., in the United States and other countries. Third-party brands and names are for identification purposes only, and are the property of their respective owners. Additional information, including relevant terms and conditions, posted at www.skyworksinc.com, are incorporated by reference.